



# Bottigliera

Model Reg. n. TO 2010/162

Un oggetto dal design accattivante e moderno studiato per rendere più ordinata e pratica l'esposizione delle bottiglie. L'illuminazione a led posta su ogni piano consente la massima visibilità delle etichette ed un eccezionale effetto scenico.

*A component characterized by an attractive and modern design specifically intended to make more regular and practical the display of bottles. The LED lighting systems on each shelves allow maximum visibility of labels and a quite unique scenic effect.*

*Un produit beau et actuel, pour une présentation des bouteilles plus ordonnée et plus pratique. L'éclairage à LED sur chaque tablette permet la plus grande visibilité des étiquettes et un effet particulièrement spectaculaire.*

*Dieses Produkt im attraktiven und modernen Design wurde entwickelt, um in die Ausstellung von Flaschen mehr praktische Ordnung zu bringen. Die LED-Beleuchtung an den einzelnen Platten ermöglicht maximale Sichtbarkeit der Etiketten und sorgt für ein einmaliges Ambiente.*

*Un objeto con un estilo fascinante y moderno diseñado para que la exposición de las botellas sea más ordenada y práctica. La iluminación con led colocada en cada piso permite la máxima visibilidad de las etiquetas y un excepcional efecto escénico.*

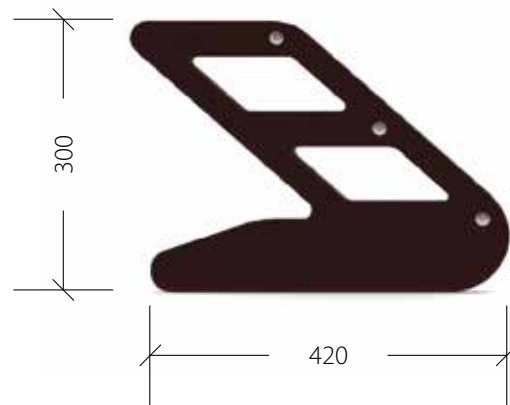

Larghezza standard cm 50 - 100 - 150 - 200  
Standard width cm 50 - 100 - 150 - 200



- 1. spalle in MDF laccato
- 1. lacquered MDF shoulders
- 1. côtés en MDF laqué
- 1. Seitenwände aus MDF
- 1. laterales de MDF lacado
- 2. piano in alluminio
- 2. aluminium top
- 2. tablette en aluminium
- 2. Aluminiumplatte
- 2. estante de aluminio

DI SERIE • STANDARD

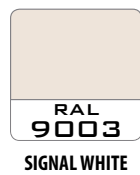

Telecomando utilizzato nella versione con Led RGB  
Remote control for RGB LED version

CODE	H L mm	≡	🍷	⚡	⬇️ W	📊 Kg
BG3** - 050	500 x 420 x 300	3	15	100 - 240V	9	5
BG3** - 100	1000 x 420 x 300	3	30	100 - 240V	20	7
BG3** - 150	1500 x 420 x 300	3	45	100 - 240V	31	10
BG3** - 200	2000 x 420 x 300	3	60	100 - 240V	42	12



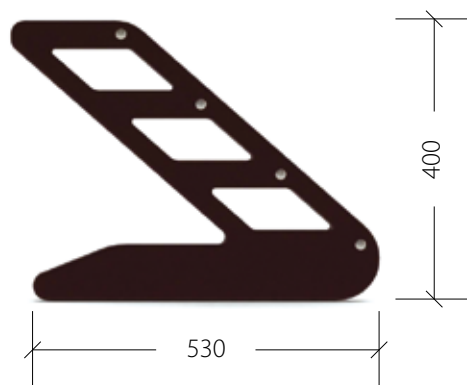

Larghezza standard cm 50 - 100 - 150 - 200  
Standard width cm 50 - 100 - 150 - 200



1. spalle in MDF laccato  
2. piano in alluminio

1. lacquered MDF shoulders  
2. aluminium top

1. côtés en MDF laqué  
2. tablette en aluminium

1. Seitenwände aus MDF  
2. Aluminiumplatte

1. laterales de MDF lacado  
2. estante de aluminio

DI SERIE • STANDARD

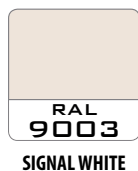
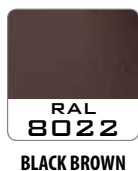

Telecomando utilizzato nella versione con Led RGB  
Remote control for RGB LED version

CODE	mm					
BG4** - 050	500 x 530 x 400	4	20	100 - 240V	12	6
BG4** - 100	1000 x 530 x 400	4	40	100 - 240V	26	9
BG4** - 150	1500 x 530 x 400	4	60	100 - 240V	41	11
BG4** - 200	2000 x 530 x 400	4	80	100 - 240V	55	13



# Legenda



## LEGEND



## LÉGENDE































## LEGENDE



## LEYENDA



CODE	Codice	Code	Code	Code	Código
	Temperatura (TA 25 °C - UR 50%)	Temperature (TA 25 °C - UR 50%)	Température (TA 25 °C - UR 50%)	Temperatur (TA 25 °C - UR 50%)	Temperatura (TA 25 °C - UR 50%)
	Umidità (TA 25 °C - UR 50%)	Humidity (TA 25 °C - UR 50%)	Humidité (TA 25 °C - UR 50%)	Feuchtigkeit (TA 25 °C - UR 50%)	Humedad (TA 25 °C - UR 50%)
	Versione	Versio n	Version	Version	Versión
	Refrigerato	Cooled	Réfrigéré	Kühlvitrine	Refrigerado
	Neutro	Neutral	Neutre	Neutralvitrine	Neutro
	Piastre eutettiche	Eutectic plates	Plaques eutectiques	Eutektische Platten	Placas eutécticas
	Riscaldato	Heated	Chauffant	Beheizt	Calentado
	Ventilato	Ventilated	Ventilé	Belüftet	Ventilado
	Tensione	Voltage	Tension	Spannung	Tensión
	Assorbimento	Absorption	Absorption	Stromaufnahme	Absorción
	Sbrinamento automatico	Automatic defrosting	Dégivrage automatique	Abtauautomatik	Desescarche automático
	Evaporazione automatica della condensa	Automatic evaporation of condensation	Évaporation automatique de la condensation	Automatische Verdunstung des Kondenswassers	Evaporación automática del vapor condensado
	Energy saving	Energy saving	Économie d'énergie	Energiesparmodus	Ahorro energético
	Gas refrigerante	Refrigerant gas	Gaz réfrigérant	Kühlgas	Gas refrigerante
	Numero piastre eutettiche	Number of eutectic plates	Nombre de plaques eutectiques	Anzahl eutektischer Platten	Número de placas eutécticas
	Luce	Light	Lumière	Beleuchtung	Luz
	Led bianco naturale	white natural daylight LED	LED blanc day-light naturel	LED naturweiß	LED blanco natural frio
	Led bianco caldo	brightwhite warm LED	LED blanc chaud	LED warmweiß	LED blanco cálido
	Led blu	Blue LED	LED bleue	Blaue LED	Led azul
	Led colorati con telecomando	Coloured LEDs with remote control	LED couleurs à télécommande	Farbige LED mit Fernbedienung	Led de colores con control remoto
	Alimentatore	Power supply adapter	Ballast	Netzteil	Alimentador
	Numero strip LED	Number of LED strips	Nombre de bandes LED	Anzahl LED-Strips	Número de tiras de LED
	Lunghezza strip LED	LED strip length	Longueur bandes LED	Länge LED-Strips	Longitud tiras de LED
	Colore	Colour	Coloris	Farbe	Color
	Finitura metallo	Metal finish	Finition métal	Metallbeschichtung	Acabado metal
	Nikel satinato	Satin nickel	Nickel satiné	Satin Nickel	Níquel satinado
	Oro lucido	Glossy gold	Doré brillant	Glänzendes Gold	Oro brillante
	Lato posteriore vetrina	Showcase back side	Face postérieure vitrine	Rückseite der Vitrine	Lado trasero vitrina
	Ante in vetro	Glass doors	Porte en verre	Glastür	Hoja de cristal
	Pannello cieco	Blank panel	Panneau borgne	Abschlussplatte	Panel ciego

					
	Numero piani (base compresa)	Number of shelves (including base)	Nombre de tablettes (base comprise)	Anzahl Etagen (Grundplatte eingeschlossen)	Número de pisos (incluida la base)
	Installazione	Installation	Installation	Installation	Instalación
PM	Appoggio - incasso	Support - built-in system	A poser - encastré	Auflage – Einbau	Apoyado - Encajado
PC	Centrale	Central	Centrale	Mitte	Central
	Numero cassetti	Number of drawers	Nombre de tiroirs	Anzahl Kassetten	Número de cajones
	Numero ante	Number of doors	Nombre de portes	Anzahl Türen	Número de hojas
	Struttura quadro vino	Structure of the wine picture-like frame	Structure cadre vin	Aufbau Weinwürfel	Estructura cuadro vino
	Cornice quadro vino	Wine picture-like frame	Structure cadre vin	Rahmen Weinwürfel	Marco cuadro vino
	Pannello quadro vino	Wine picture-like frame panel	Bordure cadre vin	Platte Weinwürfel	Panel cuadro vino
	Allestimento	Fitting-out	Aménagement	Aufhängung	Disposición
<b>A</b>	Bottiglie con colli esterni	Bottles with outer necks	Bouteilles avec goulots sur l'extérieur	Flaschen mit Hälsen nach Außen	Botellas con cuellos hacia el exterior
<b>B</b>	Bottiglie con colli passanti	Bottles with inserted necks	Bouteilles avec goulots passants	Flaschen mit Hälsen nach Innen	Botellas con cuellos encajados
<b>C</b>	Bottiglie inclinate	Inclined bottles	Bouteilles inclinées	Geneigte Flaschen	Botellas inclinadas
<b>D</b>	Piani regolabili	Adjustable shelves	Tablettes réglables	Einstellbare Etagen	Estantes ajustables
	Bottiglie	Bottles	Bouteilles	Flaschen	Botellas
	Bicchieri	Glasses	Verres	Gläser	Copas
	Kit salumeria	Salami kit	Kit salaisons	Bausatz für Wurstwaren	Kit charcutería
	Colore spalla	Shoulder colour	Coloris côté	Farbe der Seitenwände	Color lateral
	Prodotto da montare	Product to be assembled	Produit à monter	Montageprodukt	Producto a montar
	Presente	Present	Présent	Vorhanden	Presente
-	Assente / dato non disponibile	Absent / data not available	Absent / information non disponible	Nicht vorhanden / nicht verfügbar	Ausente / dato no disponible
<b>OPT</b>	Optional	Optional	En option	Optional	Opcional
	Dimensioni nette	Net dimensions	Dimensions nettes	Kantenlänge	Dimensiones netas
	Dimensioni con imballo	Dimensions including packaging	Dimensions avec emballage	Abmessung mit Verpackung	Dimensiones con embalaje
	Dimensioni con imballo su pedana	Dimensions including packing on pallet	Dimensions avec emballage sur palette	Abmessung mit Verpackung auf Gestell	Dimensiones con embalaje sobre plataforma
	Peso netto	Net weight	Poids net	Netto-Gewicht	Peso neto
	Peso con imballo	Weight with packaging	Poids avec emballage	Gewicht mit Verpackung	Peso con embalaje
	Peso con imballo su pedana	Weight with packing on pallet	Poids avec emballage sur palette	Gewicht mit Verpackung auf Gestell	Peso con embalaje sobre plataforma
	Volume con imballo	Volume with packaging	Volume avec emballage	Volumen mit Verpackung	Volumen con embalaje
	Volume con imballo su pedana	Volume with packaging on pallet	Volume avec emballage sur palette	Volumen mit Verpackung auf Gestell	Volumen con embalaje sobre plataforma
	Imballo in legno	Wooden packaging	Emballage en bois	Holzverpackung	Embalaje de madera
<b>D</b>	Descrizione	Description	Description	Beschreibung	Descripción